



CHAISE DE TRANSFERT  
TRANSFER CHAIR

swifi®

REALME

www.realme.fr



Version : 12-2013

**REALME** Tel 03 22 72 55 24  
matériel médical Fax 03 22 72 17 35  
contact@realme.fr 1 rue des violettes 80 480 SALEUX



<https://www.realme.fr/3801-chaise-transfert-promotal-swifi.html>

# swifi®

## HYGIÈNE HYGIENE

- Sellerie assise et dossier sans couture
- Chassis métallique monobloc
- Seamless seat- and back rests
- Mono block steel frame

## CONFORT COMFORT

- Panier à vêtement intégré
- Porte document intégré
- Poignée de poussée toute largeur
- Roues arrières ø 300 mm
- Accessoires nombreux
- Built-in clothes basket
- Patient file holder
- Push bar full width
- Rear casters ø 300 mm
- Various accessories

Capacité / Capacity



200 kg



## SÉCURITÉ SAFETY

- Capacité 200 kg
- Roues arrières avec freinage centralisé
- Pare chocs annulaires à l'avant
- 200 kg patient weight capacity
- Rear casters diameter 300 mm with centralised brake
- Front shock absorbers



## ACCESSIBILITÉ ACCESSIBILITY

- Appui-bras relevables
- Assise ouverte sur les côtés
- Repose-pieds escamotable par commande bilatérale au pied
- Existe en 2 largeurs (47 et 60 cm)
- Liftable armrests
- Open -sided seat
- Retractable foot rest with bilateral control
- Exists in 2 widths (47 and 60 cm)



## CARACTÉRISTIQUES STANDARD

Largeurs sellerie 47 ou 60 cm  
 Structure en tôle d'acier électrozinguée avec finition époxy gris nuage  
 Poignée de poussée finition époxy  
 Assise et dossier avec revêtement non feu M1, sans couture  
 Support dossier patient  
 Panier à vêtements  
 Appui bras relevables avec butée  
 Repose pied escamotable par commande bilatérale  
 Pare-chocs annulaires avant  
 Roues arrières ø 300 mm avec freinage centralisé  
 Roues avant ø 100 mm – roulements à billes  
 Hauteur d'assise de 58 cm  
 Capacité de charge : 200 kg (testé en statique à 600 kg)

## STANDARD FEATURES

Upholstery widths 47 or 60 cm  
 Electrogalvanized steel frame with light grey epoxy finish  
 Epoxy finished push bar  
 Backrest and seat in class M1 flame retardant seamless covering  
 Patient file holder  
 Clothes basket  
 Adjustable arm rests with stopper  
 Retractable footrest with bilateral control  
 Front shock absorbers  
 Rear castors ø 300 mm with centralized brakes  
 Front castors ø 100 mm – ball bearing  
 58 cm seat height  
 Patient weight capacity: 200 kg (tested at a static weight of 600 kg)



Modèles Models	Largeur 47 cm	Largeur 60 cm
	Width 47 cm	Width 60 cm
30130-02	●	
30130-02L		●

## Accessoires Accessories



30149-01L  
 Repose jambe avec ancrage  
 Legrest with fitting  
 (pour/for 30130-01L)



30149-01  
 Repose jambe avec ancrage  
 Legrest with fixings  
 (pour/for 30130-01)



30141-01  
 Appui-tête  
 Head rest



30140-01  
 Support poche urine  
 Urine bag support



30142-01 + 30148-20  
 Tablette support  
 Support tray

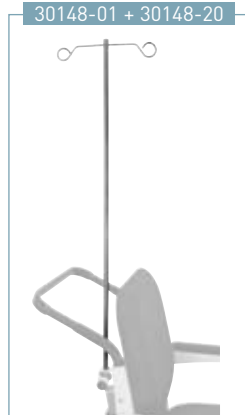

30148-01 + 30148-20  
 Tige porte sérum 2 crochets  
 2 hook IV pole

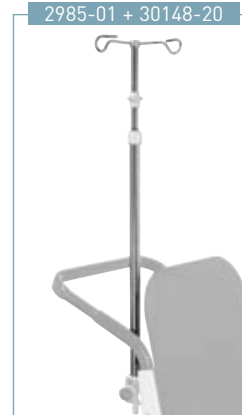

2985-01 + 30148-20  
 Tige porte sérum  
 autobloquant 2 crochets  
 2 hook auto-locking IV pole

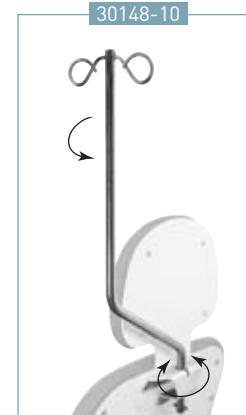

30148-10  
 Swing IV®  
 Tige porte sérum rotative  
 Rotating IV pole



30143-01  
 Ceinture de maintien  
 Safety belt

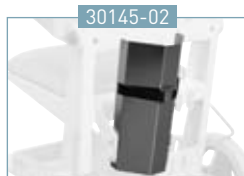

30145-02  
 Support bouteille oxygène  
 Oxygen bottle holder  
 (ø maxi 160 x h 620)

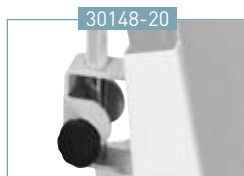

30148-20  
 Etou ø 16mm  
 Clamp ø 16 mm

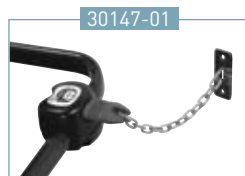

30147-01  
 Consigne à monnaie (1 €)  
 avec fixation murale  
 Coin holder (1 €)  
 with wall fixings











30147-10  
 Consigne spécial avec  
 10 jetons avec fixation murale  
 Special chair lock with  
 10 tokens with wall fixings



30147-20  
 Jeu de 10 jetons  
 Set of 10 tokens  
 (pour/for 30147-10)

**Choix de selleries non-feu M1  
Antibactérien**  
Choice of M1 fire retardant  
and antibacterial upholstery







Classic

-  32 - BLEU / BLUE
-  93 - COTTAGE / COTTAGE
-  35 - ROUGE / RED
-  34 - JAUNE / YELLOW
-  91 - BLANC / WHITE
-  92 - MARINE / MARINE
-  56 - OBSCURE / DARKNESS
-  57 - ANTISTATIQUE / ANTISTATIC  
Non classé M1 / Not classified M1



Vitamin

-  64 - RAISIN / GRAPE
-  67 - LAGON / LAGOON
-  66 - BONBON / SWEET
-  63 - CEDRAT / CEDRAT

Cosy

-  80 - CIEL / SKY
-  81 - VERT D'EAU / SEA GREEN
-  65 - LILAS / LILAC
-  96 - ETAIN / TIN
-  82 - GRIS SOURIS / MOUSE GREY
-  83 - NATUREL / NATURAL
-  84 - CHOCOLAT / CHOCOLATE

**Selleries RITTER**  
RITTER upholstery  
Non classé M1  
Not classified M1

-  C1 - NAVY
-  C2 - DUSTY BLUE
-  C3 - MOSS

ANTIBACTÉRIEN / NON FEU M1 - ANTIBACTERIAL / M1 FIRE RETARDANT



**Poids net**  
Net weight  
37 kg

**Poids brut**  
Gross weight  
42 kg  
(+ palette/pallet = + 15 kg)

**Volume 0,90 m<sup>3</sup>**  
(+ palette/pallet = 1 m<sup>3</sup>)

---

**Poids net**  
Net weight  
44 kg

**Poids brut**  
Gross weight  
50 kg  
(+ palette/pallet = + 15 kg)

**Volume 1,22 m<sup>3</sup>**  
(+ palette/pallet = 1,350 m<sup>3</sup>)

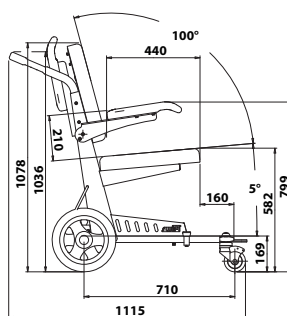
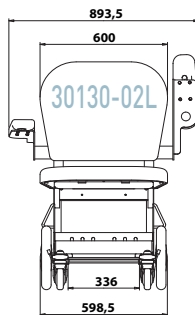
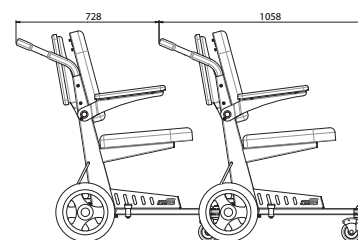
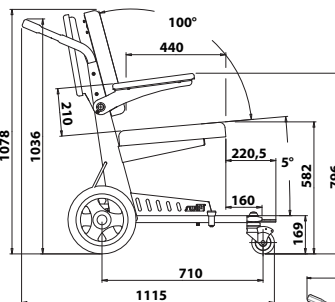
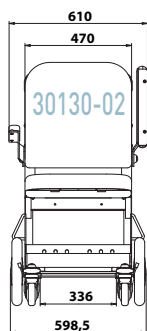

FE-49/13

**REALME**  
matériel médical  
Tel 03 22 72 55 24  
Fax 03 22 72 17 35  
contact@realme.fr  
1 rue des violettes 80 480 SALEUX

Midmark Europe SAS  
22, rue de Saint-Denis - 53500 Ernée  
[www.promotal.com](http://www.promotal.com)



<https://www.realme.fr/3801-choise-transfer-t-promotal-swifi.html>